

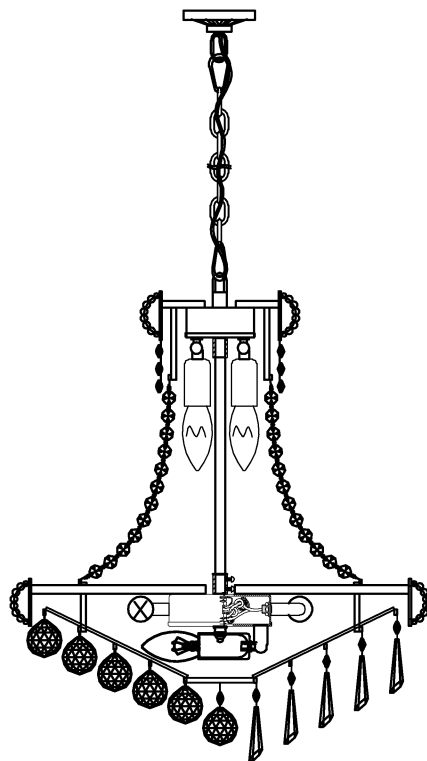

Trade Mark:
CRYSTAL WORLD INC





Product Name: Pendant lamp
Model :8040P20C
120Vac, 60Hz,AC ONLY
Lamp Size:Ø20"X24"H

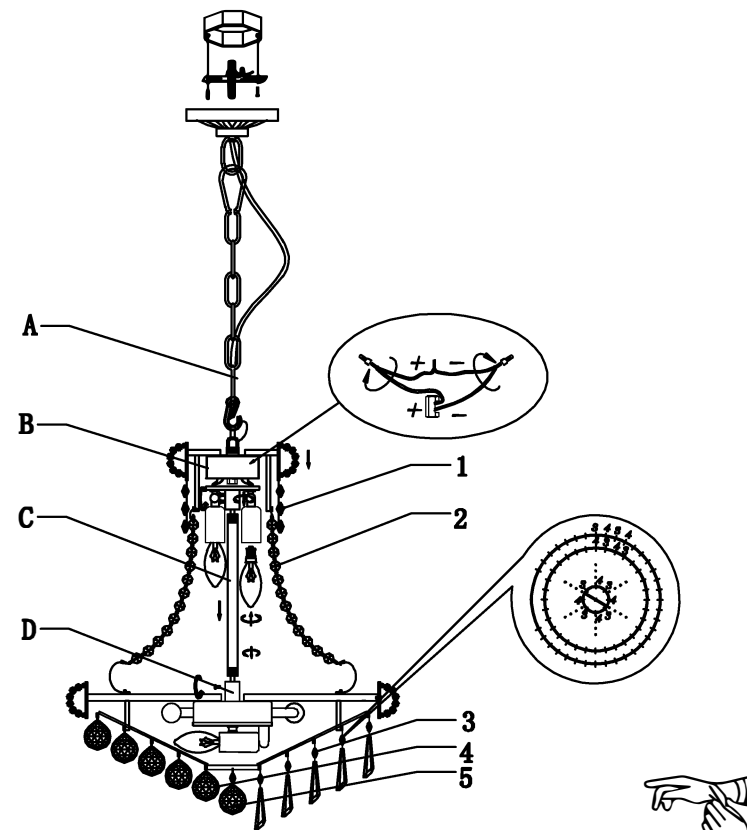

PENDANT LAMP ASSEMBLY INSTRUCTIONS

- 1.Screw part (C) onto the part (D) secure with screw.
- 2.Screw part (B) onto the part (C) secure with screw.
- 3.Please fix (A) with (B).
- 4.Please wear gloves when you hanging the crystal.
- 5.Install bulbs(NOT INCLUDED),USE 120V E12  9*40W Max.



- | | | | | |
|--|---|---|--|--|
| 
1
14mm*3pcs
27PCS | 
2
14mm*12pcs
24PCS | 
3
14mm*1pcs
63mm*1pcs
60PCS | 
4
40mm*1PCS
60PCS | 
5
14mm*1PCS
40mm*1PCS
1PCS |
|--|---|---|--|--|